



Aircraft based four-channel thermal dissociation laser induced fluorescence instrument for simultaneous measurements of NO₂, total peroxy nitrate, total alkyl nitrate, and HNO₃

P. Di Carlo^{1,2}, E. Aruffo^{1,2}, M. Busilacchio^{1,2}, F. Giammaria², C. Dari-Salisburgo^{1,2}, F. Biancofiore^{1,2}, G. Visconti^{1,2}, J. Lee³, S. Moller³, C. E. Reeves⁴, S. Bauguitte⁵, G. Forster⁴, R. L. Jones⁶, and B. Ouyang⁶

¹Center of Excellence CETEMPS, Università degli studi di L'Aquila, Via Vetoio, 67010 Coppito, L'Aquila, Italy

²Dipartimento di Scienze Fisiche e Chimiche, Università degli studi di L'Aquila, Via Vetoio, 67010 Coppito, L'Aquila, Italy

³Department of Chemistry, University of York, York, UK

⁴School of Environmental Sciences, University of East Anglia, Norwich, UK

⁵Facility for Airborne Atmospheric Measurements, Bedfordshire, UK

⁶Department of Chemistry, University of Cambridge, Cambridgeshire, UK

Correspondence to: P. Di Carlo (piro.dicarlo@aquila.infn.it)

Received: 21 November 2012 – Published in Atmos. Meas. Tech. Discuss.: 6 December 2012

Revised: 18 February 2013 – Accepted: 17 March 2013 – Published: 12 April 2013

Abstract. A four-channel thermal dissociation laser induced fluorescence (TD-LIF) instrument has been developed for simultaneous measurements of nitrogen dioxide (NO₂), total peroxy nitrate (\sum PNs), total alkyl nitrate (\sum ANs) and nitric acid (HNO₃). NO₂ is measured directly by LIF at 532 nm, whereas organic nitrates and nitric acid are thermally dissociated at distinct temperatures in the inlet to form NO₂, which is then measured by LIF. The concentrations of each dissociated species are derived by the differences in measured NO₂ relative to the reference colder inlet channel. The TD-LIF was adapted to fly on board the UK Facility for Airborne Atmospheric Measurements (FAAM) BAe 146-301 atmospheric research aircraft in summer 2010, and to date has successfully flown in five field campaigns. This paper reports novel improvements in the TD-LIF instrumentations, including (1) the use of a single wavelength laser, which makes the system compact and relatively cheap; (2) the use of a single beam laser that allows easy alignment and optical stability against the vibrational aircraft environment; and (3) the optical assembly of four detection cells that allow simultaneous and fast (time resolution up to 0.1 s) measurements of NO₂, \sum PNs, \sum ANs and HNO₃. Laboratory-generated mixtures of PNs, ANs and HNO₃ in zero air are converted into NO₂ and used to fix the dissociation temperatures of each heated inlet to test the selectivity of the instrument and po-

tential interferences due to recombination reactions of the dissociated products. The effectiveness of the TD-LIF was demonstrated during the RONOCO aircraft campaign (summer 2010). A chemiluminescence system that was measuring NO₂ and a broadband cavity enhanced absorption spectrometer (BBCEAS) that was measuring one of the PNs (N₂O₅) were installed on the same aircraft during the campaign. The in-flight intercomparison of the new TD-LIF with the chemiluminescence system for NO₂ measurements and the intercomparison between \sum PNs measured by the TD-LIF and N₂O₅ by the BBCEAS are used to assess the performance of the TD-LIF.

1 Introduction

Atmospheric peroxy nitrates (PNs or RO₂NO₂), alkyl nitrates (ANs or RONO₂) and nitric acid (HNO₃) are high oxides of nitrogen formed as intermediate or final products in the oxidation chains of volatile organic compounds (VOC) that, in the presence of nitrogen oxides (NO_x = NO + NO₂), may produce ozone (O₃). The main branch of the reaction between RO₂ and NO produce NO₂, which upon photolysis generates O₃, while a minor branch makes ANs; therefore the alkyl nitrate concentrations are generally considered as a

good indication of ozone production. PNs are generated from the reaction of RO_2 with NO_2 , and their lifetime is strongly controlled by atmospheric temperature. Consequently, because $\sum\text{PNs}$ are stable at low temperature and they have a lifetime of several months in the colder regions of the atmosphere (mid to upper troposphere or high latitudes), they are reservoirs of NO_x and they can undertake long-range transport. This is one of the mechanisms for transporting NO_x from emission sites to remote places across long distance. HNO_3 is one of the effective sinks for NO_x and for the main atmospheric oxidant hydroxyl radical ($\text{OH} + \text{NO}_2 \rightarrow \text{HNO}_3$), owing to its high stability in the atmosphere. HNO_3 is very water soluble, whereas organic nitrates (PNs and ANs) are weakly water soluble. Despite these different characteristics, PNs, ANs and HNO_3 are important components of the total reactive nitrogen ($\text{NO}_y = \text{NO} + \text{NO}_2 + \text{PN} + \text{AN} + \text{HNO}_3 + \text{NO}_3 + 2 \times \text{N}_2\text{O}_5 + \text{HONO} + \text{other nitrates}$) and they may act as a sink or a reservoir of NO_x . Due to their tight connection with the production of a pollutant and greenhouse compound like O_3 , organic nitrates and HNO_3 have been studied in detail in recent years, but various aspects of their atmospheric chemistry are still not completely understood, for example the products of the OH-initiated degradation of organic nitrate. In fact it is still uncertain if the reaction of organic nitrates with OH leads to a release of NO_x , retention of the nitrate group, or additional NO_x sequestration (Monks et al., 2009). Field campaigns and chamber experiments have shown that the oxidation of isoprene, the most emitted biogenic VOC, generates nitrates that can be the main fraction of alkyl nitrates, at least in sites dominated by natural emission of VOC (Chen et al., 1998; Beaver et al., 2012). Model simulations have shown that uncertainties in the amount of nitrates produced by isoprene oxidation can impact ozone production by about 10% in the southeastern United States (Xie et al., 2012). The natural release of organic nitrates is also an area of uncertainty, in fact there are regions where the ocean seems to be a source of ANs and others where it acts as a sink (Blake et al., 2003; Chuck et al., 2002).

Individual organic nitrates have been measured with high sensitivity in several ground-based and aircraft campaigns, using gas chromatography (GC), which has the advantage of giving the concentrations of individual organic nitrates, but requires calibration for each of them. The time resolution is also quite low (Hao et al., 1994; Flocke et al., 2005; Reeves et al., 2007). GC thermal dissociation of organic nitrates followed by chemiluminescence detection of NO_2 is a way to circumvent the need for calibration and to improve the time resolution of the GC up to 1 min (Hao et al., 1994; Marley et al., 2004). Thermal dissociation–chemical ionization mass spectrometry (TD-CIMS) technique has also been used to observe some organic nitrates like peroxyacetyl nitrate (PAN), peroxypropionyl nitrate (PPN), peroxyethacryloyl nitrate (MPAN), the sum of N_2O_5 and NO_3 , and HNO_3 at high time resolution (less than 0.3 s), fast enough to retrieve their flux

using the eddy covariance technique (Slusher et al., 2004; Turnipseed et al., 2006).

In the last decade a new approach has been tested and used in several field campaigns; this takes advantage of the fact that all compounds of the form RO_2NO_2 have a similar thermal decomposition temperature into NO_2 and that this temperature is significantly different from the dissociation temperature of all the species of the form RONO_2 and both are distinct from that of HNO_3 (Day et al., 2002). Cohen's group at the University of California, Berkeley (USA), has developed a system that heats atmospheric air at three separate temperatures to thermally dissociate total PNs ($\sum\text{PNs}$), total ANs ($\sum\text{ANs}$) and HNO_3 into NO_2 , whose concentration is measured by a laser induced fluorescence (LIF) system (Day et al., 2002). Recently it has been shown that, at a temperature sufficient to thermally dissociate $\sum\text{ANs}$ into NO_2 , also nitryl chloride (ClNO_2) can be dissociated into NO_2 (Osthoff et al., 2008; Thaler et al., 2011). This species represents another NO_x reservoir in the troposphere, especially during nighttime when $\sum\text{ANs}$ can also include ClNO_2 . Although this method does not allow the quantification of individual organic nitrates, the division of the NO_y into 3 groups has been used to assess the role of $\sum\text{ANs}$ in the NO_y budget. The sensitive measurements (ppt level) and high temporal resolution (< 1 s) allow the measurement of organic nitrates at remote sites and in the free troposphere, and enable their fluxes to be estimated using the eddy covariance technique (Farmer and Cohen, 2008; Perring et al., 2009). More recently, this method has been applied using a similar scheme to thermally dissociate organic nitrates followed by different techniques to detect NO_2 concentrations. A thermal dissociation cavity ring-down spectrometer (TD-CRDS) has been successfully tested in the lab and during a field campaign by Osthoff's group at the University of Calgary (Alberta, Canada) with a similar detection limit and time resolution to Cohen's TD-LIF (thermal dissociation laser induced fluorescence), with the potential advantage of not needing external calibration (Paul et al., 2009). The TD-LIF technique has been validated via intercomparison exercises with instruments using different detection techniques like CIMS (Beaver et al., 2012) or with instruments that measure single PANs species (Wooldridge et al., 2010).

In this paper a new TD-LIF system for measurements of NO_2 , $\sum\text{PNs}$, $\sum\text{ANs}$ and HNO_3 concentration on board an atmospheric research aircraft is described. The TD-LIF uses an inlet at ambient temperature to directly measure ambient NO_2 , and heated inlets to measure the abundance of $\sum\text{PNs}$, $\sum\text{ANs}$ and HNO_3 . It is similar to that used by Cohen's group (Day et al., 2002) but in this work a simpler laser with a fixed wavelength is used to make the system easier to align, stable under in-flight vibrations and to supply enough power to be used in a series of 4 distinct cells to simultaneously measure NO_2 , $\sum\text{PNs}$, $\sum\text{ANs}$ and HNO_3 with high time resolution. Results of laboratory tests to check the performance of the TD-LIF and to quantify possible interferences were also

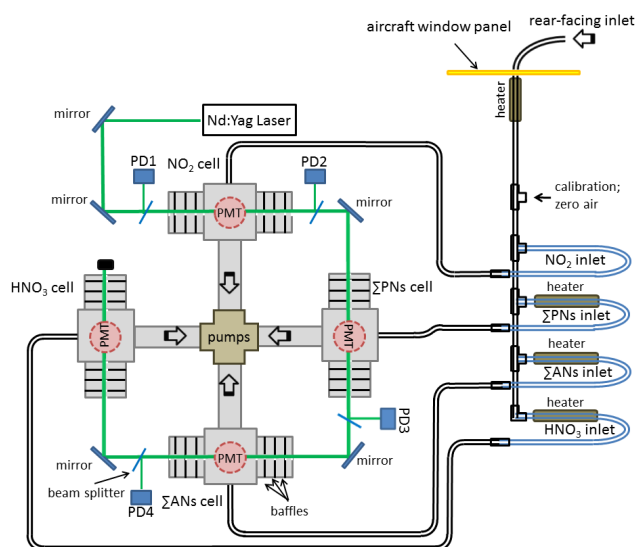

Fig. 1. The optical layout of the TD-LIF with schematics of the inlet system. Note that, to simplify the scheme the tube lengths are different here, but in the instrument the length of each of them from the inlet to the detection cell is identical to ensure the same residence time. PD1–PD4 are the four photodiodes monitoring the laser power.

presented. Since the TD-LIF is included in the suite of the instruments on board the Facility for Airborne Atmospheric Measurements (FAAM) BAe 146-301 research aircraft, and in one of the campaigns it was used concurrently with other systems, we are able to show in-flight measurements and comparisons with a couple of different instruments that were measuring NO_2 and ΣPNs .

2 The TD-LIF Instrument

The TD-LIF uses the laser induced fluorescence technique with a single-wavelength laser for direct detection of NO_2 , which has previously been applied in ground-based systems (Matsumoto et al., 2001; Dari-Salisburgo et al., 2009). Organic nitrates and HNO_3 are thermally dissociated, allowing them to be detected as NO_2 (Day et al., 2002; Paul et al., 2009). The optical layout and the inlet assembly are shown schematically in Fig. 1.

2.1 Optical layout and LIF system

The light source is a pulsed YAG-laser (Spectra-Physics, model Navigator I) that emits light at 532 nm with a power of 3.8 W, a repetition rate of 15 kHz and 20 ns pulse-width. The laser beam is sent to the first cell (for ambient NO_2 detection) using high reflectivity mirrors (> 99% at 532 nm and 45 degree). The laser light that emerges from the NO_2 cell is directed to the ΣPNs cell by another high reflectivity mirror; an identical optical scheme is used to steer the

laser beam from the exit of the ΣPNs cell to the ΣANs cell and finally to the HNO_3 cell. All the cells are identical with a cubic core of 8 cm length and two arms on the opposite faces of the cube to hold a sequence of baffles to reduce the laser scattering. The walls of the cell, arms and baffles are coated with a low fluorescent optical black paint (MH2200, IIT Research Institute). All the cells are fixed on an optical table fitted in the middle of the FAAM rack to fly on board the BAe 146-301 research aircraft using anti-vibration mounts (Fig. 2). The TD-LIF system, including the FAAM rack, weighs 224 kg and the power consumption is less than 1.5 kW. The laser head is attached below the optical table to be joined with the cells and to benefit from anti-vibration mounts. The air flow is ensured by a modified automobile supercharger (Lysholm 3300), used as a roots blower backed by a rotary pump (Leybold D25B), is perpendicular to the laser beam and the fluorescence light emitted by excited NO_2 molecules is collected perpendicular to both using a photomultiplier (PMT) made by Hamamatsu (model 7421-50). To increase the photon collection efficiency, two lens (5 cm-diameter; 60 mm focal length and 10 mm focal length, respectively) are placed before the PMT and an aluminum coated concave mirror is mounted below the center of the cell to send fluorescent photons in the direction of the PMT (Dari-Salisburgo et al., 2009). Before the PMT a series of low fluorescence optical filters is used to separate fluorescent light from non-fluorescence photons that are collectively considered background: (1) two long pass filters (cut wavelengths 620 and 640 nm, 25 mm diameter, transmission more than 85% above 640 nm) and (2) two filters to reject the laser Rayleigh scatter (a razor 532 nm and a notch 532 nm filter of 25 mm diameter, 10^6 attenuation at 532 nm and transmission about 95% above 532 nm) (Dari-Salisburgo et al., 2009). To further reduce the background, the photon detection is temporarily activated after each laser pulse for a few μs and then deactivated until the end of the subsequent laser pulse (Dari-Salisburgo et al., 2009). The laser power is monitored with four photodiodes (UDT55) at the entrance of each cell.

2.2 Sampling and inlet system

Ambient air is sampled from a common rear-faced inlet (PFA tube of 120 cm, 6.4 mm OD and 3.8 mm ID) at a flow rate of $\sim 8.4 \text{ L min}^{-1}$. The first part of the common inlet is heated (Fig. 1) to minimize HNO_3 wall loss (Neuman et al., 1999; Day et al., 2002). The air flow is split into four channels and passes through U-shaped quartz tubes (60 cm length, 6 mm OD, 3.8 mm ID). The first quartz tube is kept at ambient temperature and the sampled air goes to the first cell for ambient NO_2 measurements, whereas the other three are heated at different temperatures to thermally dissociate ΣPNs , ΣANs and HNO_3 into NO_2 . Concentrations of the resultant NO_2 are measured in the last three distinct cells. Aerosol nitrates can be thermally dissociated like gas phase nitrates, therefore they can contribute in the measured total nitrates (Day et al.,

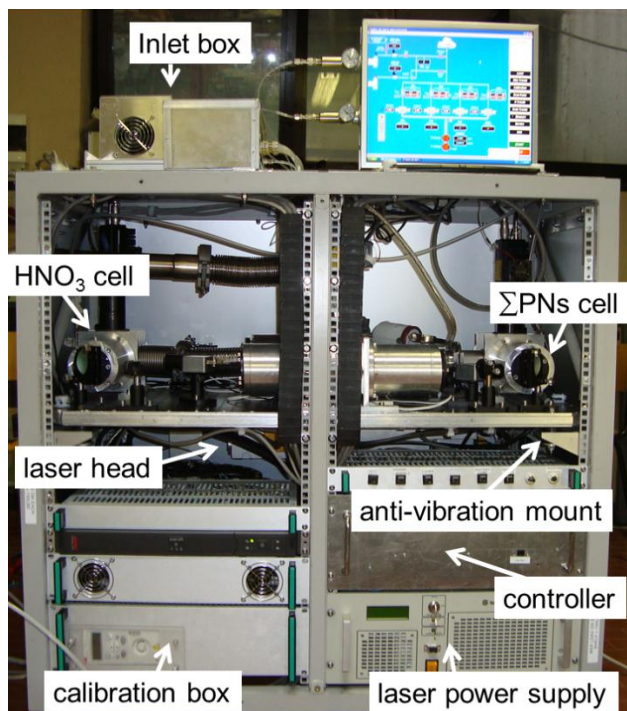

Fig. 2. A photograph of the TD-LIF installed in the rack for use on board the FAAM BAe 146-301 research aircraft. The inlet box includes the quartz tubes with heater for thermal dissociation of organic nitrates and HNO_3 into NO_2 .

2002). The air is heated using a 132 W wire (Watlow) coiled around the first 20 cm of the quartz tubes. Each tube temperature is monitored with a K-type thermocouple used also for the feedback of the power controller (STOM 1, United Automation) of the wire heater. The thermocouples are fixed on the external surface of the quartz tubes in order not to perturb the sampled air; therefore their temperatures are different from the air temperatures inside the tubes and their settings are identified by sampling synthetic organic nitrates and HNO_3 and scanning the heater temperatures to find those that guarantee the complete dissociation of these species into NO_2 . Figure 3 shows an example of the temperature scan while the TD-LIF was sampling synthetic PAN, ethyl nitrate and HNO_3 . PAN was generated in the laboratory by acetone photolysis at 285 nm in the presence of O_2 and NO (Flocke et al., 2005); a dilute mixture of ethyl nitrate was generated using liquid ethyl nitrates (SelecLab Chemical, 5 % in ethanol), diluted and flushed with a small flow of zero air; and finally HNO_3 was generated by flowing zero air through a heated permeation tube (Kin-Tek) (McKinley and Merriman, 1996). The 3 distinct temperatures (150–250 °C), (350–450 °C) and above 550 °C when complete dissociation of ΣPNs , ΣANs and HNO_3 takes place are evident in Fig. 3. These setting temperatures may need to be re-adjusted upon changing the assembly of the heater wire and of the thermocouple, and therefore are indicative and must be checked periodically,

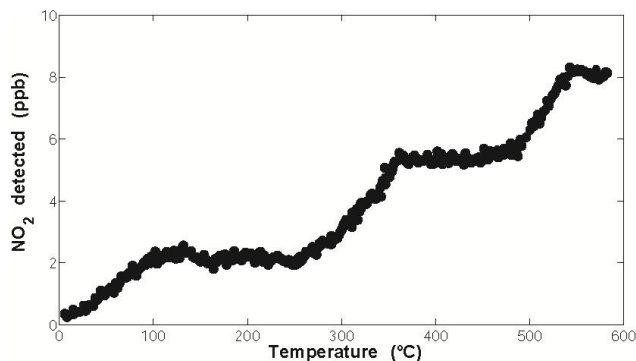

Fig. 3. Temperature scan when the TD-LIF sampled synthetic PAN, ethyl nitrates and HNO_3 , generated in the laboratory to identify the temperatures where these compounds are thermally dissociated into NO_2 .

particularly when parts (mainly the heater wire or the thermocouple) are replaced. Laboratory tests carried out to check the selectivity of the TD-LIF and for possible interferences are described in a dedicated section below.

The flow rate and the residence time through the quartz tubes where the heater is mounted are 2.1 L min^{-1} and 30 ms, respectively. Sample air at the exit of the quartz tube undergoes a pressure drop of 93 % from ambient pressure to about 50 torr, passing through a pinhole. This pressure drop reduces the residence time of the sample gas between the heater region and the detection cell minimizing the occurrence of recombination reactions. From the pinhole (after the quartz tube) and the detection cell, the sample air traverses a PFA tube of the same size as the inlet tube and about 100 cm long (residence time in this tube is 90 ms). This PFA tube delivers sample air to a stainless steel nozzle in the detection cell, where the pressure drops to about 4 torr. Considering that the residence time of the first part of the sampling tube (from the inlet to the heaters) is 400 ms, the total residence time from the inlet to the detection cell is about 490 ms.

2.3 Data acquisition

A PXI unit 1033 (National Instruments, NI) equipped with fast (16 bit) multifunction modules (NI PXI 6259 and NI PXI 6608) is used to control the gate of the PMTs, the acquisition of the PMT signals and their digitalization (Dari-Salisburgo et al., 2009). A C-RIO (NI model 9002) is mainly dedicated to the control of the inlet box. It includes a thermocouple module (NI 9211) and analog and digital modules (NI 9263, NI 9474) to control valves, pumps and all the other components of the TD-LIF. The software that controls the instrument and allows periodical calibrations and zeroing is written in LabVIEW (NI), held by a supervision software, written in Lockout (NI), that allows on-line historical data trends of all the variables acquired during the measurements.

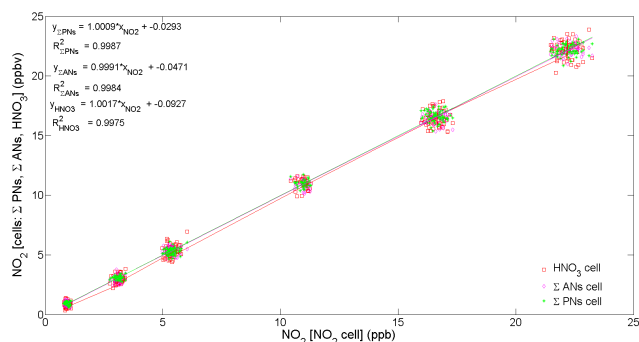

Fig. 4. Intercomparison between the first cell and the other three cells when the common inlet sampled different concentrations of NO_2 , sent using the calibration system of the TD-LIF.

2.4 Data retrieval and calibration

The TD-LIF measures NO_2 directly and by subtraction organic nitrates and HNO_3 can be calculated. All the four cells measure NO_2 concentrations with the following differences: the first, which samples air at ambient temperature, gives ambient NO_2 concentrations; the second cell that samples air heated to temperatures between 150 and 250 °C measures ambient NO_2 plus the NO_2 generated from the thermal dissociation of ΣPNs ; the third cell, since sample air is heated in the inlet channel to temperatures between 350 and 450 °C, detects ambient NO_2 plus the NO_2 generated from the thermal dissociation of ΣPNs and ΣANs ; and finally the last cell samples air heated to more than 550 °C and so measures ambient NO_2 plus the NO_2 generated from the thermal dissociation of ΣPNs , ΣANs and HNO_3 . The heated cells dissociate all the gas phase nitrates, but also any aerosol phase nitrates (Day et al., 2002). The concentrations of ΣPNs are calculated by subtracting the NO_2 measured in the second cell from that of the first cell, ΣANs concentrations by subtracting the NO_2 measured in the third cell from that of the second cell, and HNO_3 concentrations are calculated by subtracting the NO_2 measured in the fourth cell from that of the third cell. Since organic nitrates and HNO_3 are calculated as the difference between the total NO_2 observed by each cell and that of the colder one, an intercomparison between cells was performed to check if there is a substantial difference in the behavior of each cell because the detection limit and accuracy of the measurements of the dissociated compounds depends on the detection limit and accuracy of the NO_2 measured by every cell. Figure 4 shows the intercomparison of the second, third and fourth cells with the first one when a known amount of NO_2 is sampled by the common manifold. As expected, the performance decreases from the second to the fourth cell since the laser energy decreases and its divergence increases, but all of them show a slope very close to unity and a bias that goes from 29 to 92 ppt. The detection limits are 9.8, 18.4, 28.1 and 49.7 pptv (1 s, $S/N = 2$) for detection of NO_2 by the NO_2 cell, ΣPNs cell,

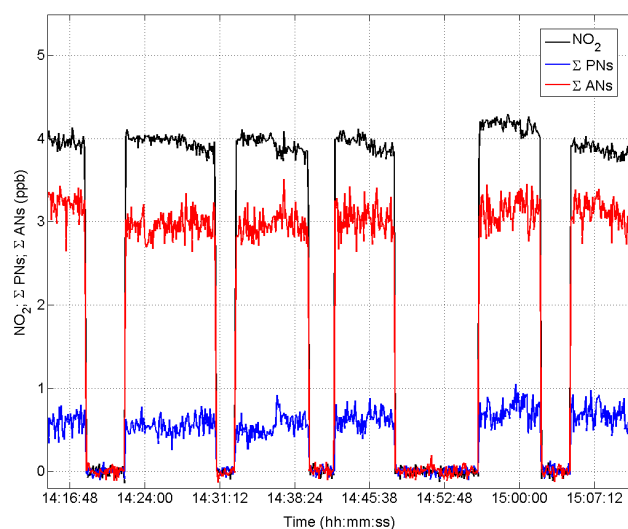

Fig. 5. Measurements of a mixture of NO_2 , PAN and ethyl nitrate with distinct cells of the TD-LIF generated in a laboratory test. Zero air is sent periodically to check the capability of the system to flush the organic nitrates.

ΣANs cell and HNO_3 cell, respectively. The accuracy depends on the uncertainty of the standards and mass flow controller used for the calibration, which in this configuration is 10, 22, 34 and 46 % for NO_2 cell, ΣPNs cell, ΣANs cell and HNO_3 cell, respectively. As mentioned, ΣPNs , ΣANs and HNO_3 are calculated by subtracting the signal of two channels. Therefore the detection limit of each of them depends on the signal and uncertainties of these two channels (Day et al., 2002):

$$(B - A) \pm (\sigma_A^2 + \sigma_B^2)^{1/2}, \quad (1)$$

where A and B are the signals from adjacent channels (NO_2 cell and ΣPNs cell to retrieve ΣPNs concentrations or ΣPNs cell and ΣANs cell to calculate ΣANs concentrations) and σ is the associated uncertainties in each channel. For example, for about 90 pptv of background NO_2 the detection limit of ΣPNs is 120 pptv (10 s, $S/N = 2$), for about 300 pptv of background ΣPNs it is 240 pptv (10 s, $S/N = 2$), and for ΣANs and for about 70 pptv of background ΣANs it is 420 pptv (10 s, $S/N = 2$) for HNO_3 .

The TD-LIF is routinely calibrated against standard NO_2 using a cylinder of 5 to 8 ppm of NO_2 in zero air (SIAD SIT certificate, NIST traceable) diluted in zero air (Darisaliburgo et al., 2009). Since all the cells measure NO_2 they are calibrated only for NO_2 since in the heated inlets ΣPNs , ΣANs and HNO_3 achieve a complete dissociation into NO_2 (Hao et al., 1994; Zabel, 1995; Kirchner et al., 1999; Day et al., 2002).

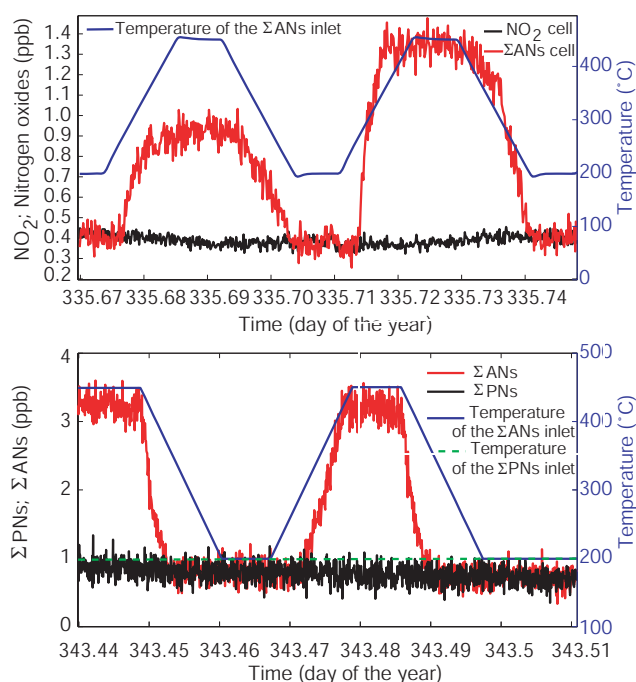

Fig. 6. Upper panel: temperature scan of the Σ ANs inlet channel when the TD-LIF sampled a mixture of ethyl nitrate and NO_2 . After the first temperature scan the concentration of ethyl nitrate was doubled. For all the experiments the NO_2 cell sampled air at ambient temperature. Lower panel: temperature scan of the Σ ANs inlet channel when the TD-LIF sampled a mixture of ethyl nitrate and PAN. For all the experiments the Σ PNs inlet channel was heated to 200°C to detect PAN.

3 Results

3.1 Laboratory tests: zeroing and selectivity

Figure 5 shows a time series of NO_2 , PAN and ethyl nitrates detected by the first three cells of the TD-LIF. A mixture of about 4 ppbv of NO_2 , 800 pptv of PAN and 3 ppbv of ethyl nitrates was generated in the laboratory and sent to the common inlet, with the Σ PNs inlet channel heated at 200°C , the Σ ANs inlet channel at 450°C and that of NO_2 at ambient temperature. A high-purity zero air is periodically sent to the common inlet to check if all the cells, including those that sample heated air, reach the zero level. All the cells go to zero when zero air is sampled with no residue of the organic nitrates and NO_2 sent previously, and they reach zero with no lag-time and all simultaneously.

To determine the response of the TD-LIF as a function of the inlet temperature and its selectivity to separate organic nitrates, a series of experiments were carried out. Figure 6 (upper panel) shows a test where the common inlet sampled a mix of ethyl nitrates and NO_2 while the temperature of the Σ ANs inlet channel was changing from 200 to 450°C and the NO_2 inlet channel was at ambient temperature. At the beginning about 0.45 ppbv of NO_2 and 0.5 ppbv of ethyl nitrate

were delivered to the common inlet and the temperature of the Σ ANs inlet channel was kept at 200°C , which is the set temperature for the thermal dissociation of Σ PNs into NO_2 . In this first part of the experiment the Σ ANs cell measured exactly the same NO_2 concentration observed by the NO_2 cell even if it was sampling 0.5 ppbv of ethyl nitrate. This gives two insights: (1) At the temperature of Σ PNs thermal dissociation, ethyl nitrate, which is one of the Σ ANs, is not dissociated into NO_2 and therefore the Σ PNs channel does not suffer interference due to the presence of ethyl nitrate, and since all the ANs compounds have the same dissociation temperature of ethyl nitrate it does not suffer interference due to the presence of Σ ANs (Day et al., 2002). (2) The Σ ANs channel, when not heated to the right temperature to dissociate Σ ANs, measures only ambient NO_2 and at exactly the same concentrations detected by the cell that samples from the inlet at ambient temperature without bias or interferences due to the presence of one AN. After some time sampling with the Σ ANs inlet channel kept at 200°C , this temperature was increased up to 450°C , and kept at this temperature for a while. As the temperature rose the NO_2 concentration detected by the Σ ANs cell increased, and when the heater temperature reached 450°C the cell detected about 0.9 ppbv of NO_2 from the background NO_2 sent to the inlet plus that converted from 0.5 ppbv of ethyl nitrate. Later, after switching off the heater, the temperature of the Σ ANs inlet channel dropped back to 200°C and again the Σ ANs cell detected the same amount of NO_2 as measured by the first cell. At around day 343.52 (day of the year) the amount of ethyl nitrate was doubled and the temperature of the Σ ANs inlet channel rose again to 450°C . At this temperature, as expected, the Σ ANs cell measured the NO_2 sent plus two times the previous NO_2 measured due to the dissociation of twice the concentration of ethyl nitrate. Also in this situation, when the heater of the Σ ANs inlet channel was switched off the Σ ANs cell detected the same amount of NO_2 as measured by the NO_2 cell. Figure 6 (lower panel) shows another experiment to further check the selectivity of the TD-LIF. During this test a synthetic mixture of about 0.9 ppbv of PAN and 2.4 ppbv of ethyl nitrate was supplied to the common inlet of the TD-LIF. The temperature of the Σ PNs inlet channel was kept at 200°C for the whole experiment and its cell detected about 0.9 ppbv with a slight decline due to a small decrease in the concentration of PAN sent. At the beginning the temperature of the Σ ANs inlet channel was kept at 450°C and, as expected, the Σ ANs cell detected about 3.3 ppbv of NO_2 that was the result of the thermal dissociation of 0.9 ppbv of PAN and 2.4 ppbv of ethyl nitrate. Later, reducing the temperature of the Σ ANs inlet channel from 450 to 200°C , the Σ ANs cell detected exactly the same concentrations as the Σ PNs cell. This experiment was concluded with another rise and drop of the Σ ANs inlet channel to confirm again that at 450°C the Σ ANs cell measured PAN plus ethyl nitrates, whereas at 200°C only PAN. This is further proof that the inlet system set at two distinct temperatures is able to separate

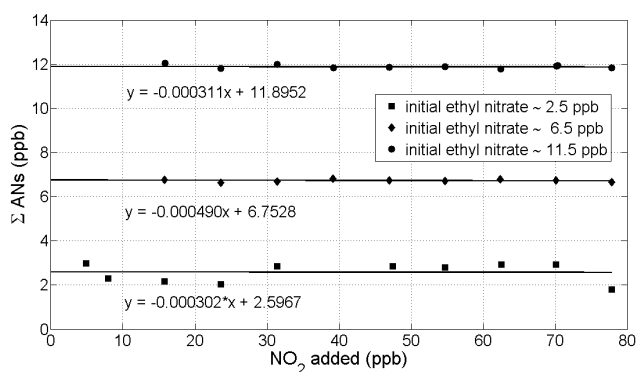

Fig. 7. Measurements of Σ ANs when the TD-LIF sampled a mixture of ethyl nitrate and different concentrations of NO_2 to check for possible interference of the recombination of compounds produced during the dissociation of Σ ANs. This experiment was carried out for different initial concentrations of ethyl nitrate.

PAN from ethyl nitrates, and since all the PN compounds have the same dissociation temperature as PAN and all the ANs the same as ethyl nitrate (Day et al., 2002), the TD-LIF can reliably detect Σ PNs and Σ ANs.

3.2 Laboratory tests: Conversion efficiency of ANs and PNs in presence of NO_2

One of the concerns in the detection of organic nitrates by thermal dissociation is that the potential recombination of dissociated products could be a possible interference. For example, when ANs are thermally dissociated they produce RO and NO_2 ; the latter is detected by the TD-LIF to calculate the amount of ANs, but the first can react with NO_2 and reproducing ANs. A series of lab tests were performed to check the probability of recombination of dissociated products. Figure 7 shows TD-LIF measurements of the Σ ANs channel when a laboratory-generated mixture of ethyl nitrate and NO_2 was delivered to the TD-LIF inlet. When the initial ethyl nitrate sent was 2.5 ppbv, no significant recombination was observed with NO_2 concentrations up to 80 ppbv: the slope of the linear fit was 0.0003, which indicates a possible interference of 0.3 pptv per ppbv of NO_2 , a value well below the detection limit of the system. A similar insignificant recombination effect was observed when the initial ethyl nitrate was about 6.5 and 11.5 ppbv. Figure 8 shows the Σ PNs detected by the cell that sampled air heated at 200 °C when about 2.3 ppbv of PAN was sent to the TD-LIF inlet together with known amounts of NO_2 that were increased step by step up to 80 ppbv. This experiment was carried out to test if the addition of NO_2 suppresses the Σ PNs concentration due to recombination of RO_2 and NO_2 . The linear fit gives a slope of -0.0030 , which implies a suppression of Σ PNs at the rate of -3 pptv per ppbv of NO_2 added, a small interference and similar to that observed with other TD-LIF and TD-CRDS (Day et al., 2002; Paul et al., 2009).

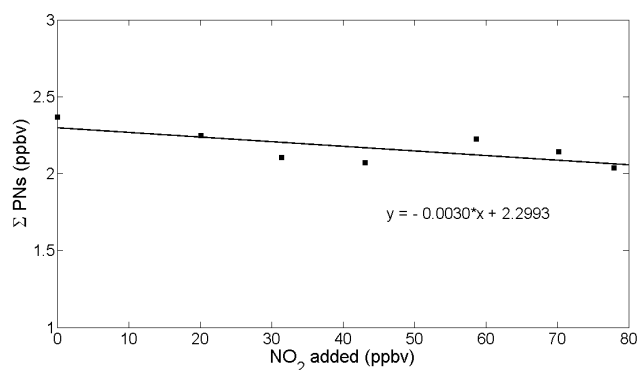

Fig. 8. Measurements of Σ PNs when the TD-LIF sampled a mixture of PAN and different concentrations of NO_2 to check for possible interference due to the recombination of RO_2 and NO_2 .

4 Comparison of in-flight measurements of TD-LIF

4.1 Nitrogen dioxide: TD-LIF vs. chemiluminescence detector

In summer 2010, the TD-LIF was installed for the first time on board the UK FAAM BAe 146-301 atmospheric research aircraft during the Role of Nighttime Chemistry in Controlling the Oxidising Capacity of the Atmosphere (RONOCO) campaign. RONOCO was a nighttime campaign aimed to study the role of NO_3 and N_2O_5 in the after-dawn chemistry of the atmosphere, with a few flights carried out during the day. The campaign was based at East Midland airport (UK) to study the chemistry over the UK during two periods: July/August 2010 and January 2011, with 25 research flights.

The BAe 146-301 research aircraft was fitted with several instruments to measure trace gas concentrations, aerosol physical and chemical characteristics and meteorological parameters; among them there was a chemiluminescence (CL) detector which provided measurements of NO_2 concentrations with a technique completely different from the TD-LIF. The CL detector uses a photolytic converter (blue-light LED, centered at 395 nm) to convert NO_2 into NO , whose concentration is monitored via the detection of the $\text{NO} + \text{O}_3$ chemiluminescence photons (Kley and McFarland, 1980). Several intercomparisons among NO_2 instruments have been executed in recent years; one very comprehensive comparison, using five different NO_2 detectors, was carried out in a simulation chamber and showed good agreements between CL detector and some other NO_2 instruments, including a LIF system (Fuchs et al., 2010). The BAe-146 CL system undertook regular in-flight calibrations and its inlet was located on the same side and less than 8 m away from the TD-LIF inlet. The upper panel in Fig. 9 shows the time series of NO_2 measured by the TD-LIF and by the CL detector during the first flight of the RONOCO campaign on the night of 16/17 July 2010. The TD-LIF and CL data were acquired

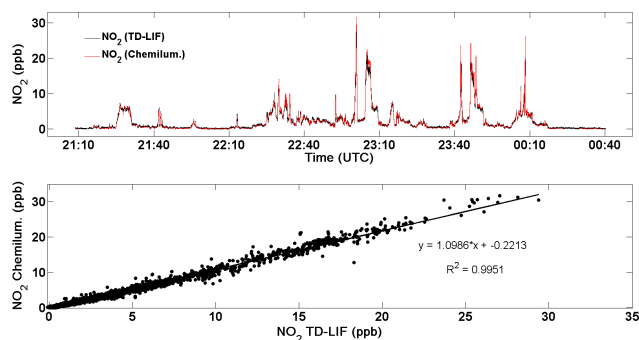

Fig. 9. Upper panel: time series of in-flight measurements of NO₂, on board the research aircraft BAe 146-301, detected by a chemiluminescence system and by the TD-LIF. Lower panel: scatter plot of NO₂ measured by a chemiluminescence system and by the TD-LIF reported in the upper plot of this figure.

with 0.1 s and 1 s integration time, respectively, but to compare at the same time frequency the TD-LIF data have been averaged over 1 s intervals. The upper panel in Fig. 9 shows that during the whole flight the two instruments detected very similar amounts of NO₂ and they tracked the same NO₂ variability. The lower panel of Fig. 9 shows the scatter plot of the NO₂ concentration from TD-LIF against that from CL for the whole flight. The correlation between the data observed by the two instruments is robust ($R^2 = 0.995$), a slope very close to unity (1.09) and a small intercept (0.22 ppb). This excellent agreement between TD-LIF and an independent and established system like CL validates the TD-LIF system and shows that it can be effectively used in airborne observations.

4.2 Peroxy nitrates: TD-LIF measurements of Σ PNs vs. BBCEAS measurements of N₂O₅

Another new system developed by Jones's group in Cambridge (UK), using a well-established technique to observe NO₃ and N₂O₅ (Kennedy et al., 2011), was deployed on the BAe 146-301 aircraft during the RONOCO campaigns. This new system uses broadband cavity enhanced absorption spectroscopy (BBCEAS) to measure N₂O₅, which is one of the Σ PNs and in particular the dominant one during nighttime (Day et al., 2002). Therefore even if Σ PNs include other nitrates compounds and their concentrations are usually higher than N₂O₅, a comparison between the TD-LIF and the BBCEAS serves as a good test of the performance of the first instrument, at least when Σ PNs are dominated by N₂O₅, for instance during nighttime. The results of NO₃Comp 2007 intercomparison exercise, carried out in the SAPHIR chamber, proved that three cavity ring-down instruments and two LIF instruments detect N₂O₅ with good agreement (Fuchs, et al., 2012); here we have reported the intercomparison in troposphere on board the BAe 146-301 aircraft. The upper panel of Fig. 10 shows Σ PNs measured by the TD-LIF and N₂O₅ detected by the BBCEAS during the second flight of

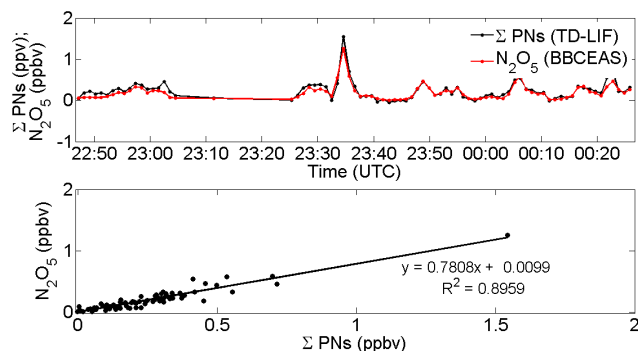

Fig. 10. Upper panel: time series of measurements on board the research aircraft BAe 146-301 of Σ PNs and N₂O₅ detected by the TD-LIF and by the BBCEAS, respectively. Lower panel: scatter plot of Σ PNs and N₂O₅ reported in the upper panel of this figure.

the RONOCO campaign on the night of 17/18 July 2010. The TD-LIF and BBCEAS data were acquired with 0.1 s and 0.4 s integration time, respectively, but for the comparison in this figure they have been averaged over 30 s intervals. The upper panel in Fig. 10 shows that in the part of the flight reported here when Σ PNs were dominated by N₂O₅, the two instruments detected very similar concentrations and they tracked the same N₂O₅ variability. The lower panel of Fig. 10 shows the scatter plot of the TD-LIF and BBCEAS for the same flight reported in the upper panel of Fig. 10. This agreement between TD-LIF measurements and an independent and established technique like BBCEAS is very good: the correlation between the data observed by the two instruments is quite strong ($R^2 = 0.896$), the slope is 0.78 and there is a very small intercept (0.009 ppb). The slope below the unity is due to other PN species detected by the TD-LIF but not measured by the BBCEAS, like PAN, PPN or MPAN that may be significant fractions of Σ PNs (Wooldridge et al., 2010). This intercomparison confirms the consistency of the Σ PNs measurements and that the TD-LIF can be efficiently used in airborne observations.

5 Conclusions

A TD-LIF system for simultaneous measurements of NO₂, Σ PNs, Σ ANs and HNO₃ was built and, after laboratory tests, installed on the UK research aircraft BAe 146-301. The system shows low detection limits for NO₂ and organic nitrates, which allows observations in different environments. Laboratory tests show the selectivity of the TD-LIF for the detection of organic nitrates and HNO₃. Experiments to identify possible interference due to the recombination of thermal dissociation products show an insignificant effect on the Σ ANs detection and a very small effect in the Σ PNs. To date the TD-LIF has been successfully operated in five field campaigns. In-flight intercomparison of NO₂ measurements between the TD-LIF and a chemiluminescence system shows

an excellent agreement. Comparison of in-flight measurements of \sum PNs measured by the TD-LIF and N_2O_5 measured by a BBCEAS system installed on the same aircraft also show a good agreement. TD-LIF has demonstrated that it is not only robust enough for in-flight observations but also sensitive enough to provide accurate measurements of NO_2 and organic nitrates.

Acknowledgements. This work was performed within the RONOCO consortium supported by the Natural Environmental Research Council (NERC) (University of Cambridge grant award reference RG50086 MAAG/606, University of Leicester grant award reference NE/F006761/1, University of East Anglia grant award reference NE/F005520/1). We acknowledge Ron Cohen and Paul Wooldridge (University of California, Berkeley, USA) for their advice on the design of the TD-LIF. We thank Francesco Del Grande (University of L'Aquila, Italy) for the building of the mechanical parts of the TD-LIF. We thank the BAe-146 pilots and all the people from FAAM, Avalon Aero and DirectFlight for their help during the RONOCO campaign. PDC works are supported by Fondazione CarispaQ.

Edited by: D. Heard

References

- Beaver, M. R., Clair, J. M. St., Paulot, F., Spencer, K. M., Crouse, J. D., LaFranchi, B. W., Min, K. E., Pusede, S. E., Wooldridge, P. J., Schade, G. W., Park, C., Cohen, R. C., and Wennberg, P. O.: Importance of biogenic precursors to the budget of organic nitrates: observations of multifunctional organic nitrates by CIMS and TD-LIF during BEARPEX 2009, *Atmos. Chem. Phys.*, 12, 5773–5785, doi:10.5194/acp-12-5773-2012, 2012.
- Blake, N. J., Blake, D. R., Swanson, A. L., Atlas, E., Flocke, F., and Rowland, F. S.: Latitudinal, vertical, and seasonal variations of C1-C4 alkyl nitrates in the troposphere over the Pacific Ocean during PEM-Tropics A and B: Oceanic and continental sources, *J. Geophys. Res.*, 108, 8242, doi:10.1029/2001JD001444, 2003.
- Chen, X. H., Hulbert, D., and Shepson, P. B.: Measurement of the organic nitrate yield from OH reaction with isoprene, *J. Geophys. Res. Atmos.*, 103, 25563–25568, 1998.
- Chuck, A. L., Turner, S. M., and Liss, P. S.: Direct evidence for a marine source of C1 and C2 alkyl nitrates, *Science*, 297, 1151–1154, 2002.
- Dari-Salisburgo, C., Di Carlo, P., Giammaria, F., Kajii, Y., and D'Altorio A.: Laser induced fluorescence instrument for NO_2 measurements: Observations at a central Italy background site, *Atmos. Environ.*, 43, 970–977, 2009.
- Day, D. A., Wooldridge, P. J., Dillon, M. B., Thornton, J. A., and Cohen R. C.: A thermal dissociation laser-induced fluorescence instrument for in situ detection of NO_2 , peroxy nitrates, alkyl nitrates, and HNO_3 , *J. Geophys. Res.*, 107, 4046, doi:10.1029/2001JD000779, 2002.
- Farmer, D. K. and Cohen, R. C.: Observations of HNO_3 , \sum AN, \sum PN and NO_2 fluxes: evidence for rapid HO_x chemistry within a pine forest canopy, *Atmos. Chem. Phys.*, 8, 3899–3917, doi:10.5194/acp-8-3899-2008, 2008.
- Flocke, F. M., Weinheimer, A. J., Swanson, A. L., Roberts, J. M., Schmitt, R., and Shertz, S.: On the Measurement of PANs by Gas Chromatography and Electron Capture Detection, *J. Atmos. Chem.*, 52, 19–43, 2005.
- Fuchs, H., Ball, S. M., Bohn, B., Brauers, T., Cohen, R. C., Dorn, H.-P., Dubé, W. P., Fry, J. L., Häsel, R., Heitmann, U., Jones, R. L., Kleffmann, J., Mentel, T. F., Müsgen, P., Rohrer, F., Rollins, A. W., Ruth, A. A., Kiendler-Scharr, A., Schlosser, E., Shillings, A. J. L., Tillmann, R., Varma, R. M., Venables, D. S., Villena Tapia, G., Wahner, A., Wegener, R., Wooldridge, P. J., and Brown, S. S.: Intercomparison of measurements of NO_2 concentrations in the atmosphere simulation chamber SAPHIR during the NO3Comp campaign, *Atmos. Meas. Tech.*, 3, 21–37, doi:10.5194/amt-3-21-2010, 2010.
- Fuchs, H., Simpson, W. R., Apodaca, R. L., Brauers, T., Cohen, R. C., Crowley, J. N., Dorn, H.-P., Dubé, W. P., Fry, J. L., Häsel, R., Kajii, Y., Kiendler-Scharr, A., Labazan, I., Matsumoto, J., Mentel, T. F., Nakashima, Y., Rohrer, F., Rollins, A. W., Schuster, G., Tillmann, R., Wahner, A., Wooldridge, P. J., and Brown, S. S.: Comparison of N_2O_5 mixing ratios during NO3Comp 2007 in SAPHIR, *Atmos. Meas. Tech.*, 5, 2763–2777, doi:10.5194/amt-5-2763-2012, 2012.
- Hao, C. S., Shepson, P. B., Drummond, J. W., and Muthuramu, K.: Gas-Chromatographic Detector for Selective and Sensitive Detection of Atmospheric Organic Nitrates, *Anal. Chem.*, 66, 3737–3743, 1994.
- Kennedy, O. J., Ouyang, B., Langridge, J. M., Daniels, M. J. S., Bauguitte, S., Freshwater, R., McLeod, M. W., Ironmonger, C., Sendall, J., Norris, O., Nightingale, R., Ball, S. M., and Jones, R. L.: An aircraft based three channel broadband cavity enhanced absorption spectrometer for simultaneous measurements of NO_3 , N_2O_5 and NO_2 , *Atmos. Meas. Tech.*, 4, 1759–1776, doi:10.5194/amt-4-1759-2011, 2011.
- Kirchner, F., Mayer-Figge, A., Zabel, F., and Becker, K. H.: Thermal stability of peroxy nitrates, *Int. J. Chem. Kinet.*, 31, 127–144, 1999.
- Kley D. and McFarland M.: Chemiluminescence detector for NO and NO_2 , *Atmos. Technol.*, 12, 63–69, 1980.
- Marley, N. A., Gaffney, J. S., White, R. V., Rodriguez-Cuadra, L., Herndon, S. E., Dunlea, E., Volkamer, R. M., Molina, L. T., and Molina, M. J.: Fast gas chromatography with luminol chemiluminescence detection for the simultaneous determination of nitrogen dioxide and peroxyacetyl nitrate in the atmosphere, *Rev. Sci. Instrum.*, 75, 4595–4605, 2004.
- Matsumoto, J., Hirokawa, J., Akimoto, H., and Kajii, Y.: Direct measurement of NO_2 in the marine atmosphere by laser-induced fluorescence technique, *Atmos. Environ.*, 35, 2803–2814, 2001.
- McKinley J. J. and Merriman, D. C.: Permeation tube sources for internal standards in process samples, *Process. Contr. Qual.*, 8, 69–74, 1996.
- Monks, P. S., Granier, C., Fuzzi, S., Stohl, A., Williams, M. L., Akimoto, H., Amanni, M., Baklanov, A., Baltensperger, U., Bey, I., Blake, N., Blake, R. S., Carslaw, K., Cooper, O. R., Dentener, F., Fowler, D., Fragkou, E., Frost, G. J., Generoso, S., Ginoux, P., Grewet, V., Guenther, A., Hansson, H.C., Henne, S., Hjorth, J., Hofzumahaus, A., Huntrieser, H., Isaksen, I. S. A., Jenkin, M. E., Kaiser, J., Kanakidou, M., Klimont, Z., Kulmala, M., Laj, P., Lawrence, M. G., Lee, J. D., Liousse, C., Maione, M., McFiggans, G., Metzger, A., Mieville, A., Moussiopoulos, N., Orlando,

- J. J., O'Dowd, C. D., Palmer, P. I., Parrish, D. D., Petzold, A., Platt, U., Poschl, U., Prevot, A. S. H., Reeves, C. E., Reimann, S., Rudich, Y., Sellegri, K., Steinbrecher, R., Simpson, D., ten Brink, H., Theloke, J., van der Werf, G. R., Vautard, R., Vestreng, V., Vlachokostas, C., and von Glasow, R.: Atmospheric composition change – global and regional air quality, *Atmos. Environ.*, 43, 5268–5350, 2009.
- Neuman, J. A., Huey, L. G., Ryerson, T. B., and Fahey, D. W.: Study of Inlet Materials for Sampling Atmospheric Nitric Acid, *Environ. Sci. Technol.*, 33, 1133–1136, 1999.
- Osthoff, H. D., Roberts, J. M., Ravishankara, A. R., Williams, E. J., Lerner, B. M., Sommariva, R., Bates, T. S., Coffman, D., Quinn, P. K., Stark, H., Burkholder, J. B., Talukdar, R. K., Meagher, J., Fehsenfeld, F. C., and Brown, S. S.: High levels of nitryl chloride in the polluted, subtropical marine boundary layer, *Nat. Geosci.*, 1, 324–328, 2008.
- Paul, D., Furgeson, A., and Osthoff, H. D.: Measurements of total peroxy and alkyl nitrate abundances in laboratory-generated gas samples by thermal dissociation cavity ring-down spectroscopy, *Rev. Sci. Instrum.*, 80, 114101–114108, 2009.
- Perring, A. E., Bertram, T. H., Wooldridge, P. J., Fried, A., Heikes, B. G., Dibb, J., Crouse, J. D., Wennberg, P. O., Blake, N. J., Blake, D. R., Brune, W. H., Singh, H. B., and Cohen, R. C.: Airborne observations of total RONO_2 : new constraints on the yield and lifetime of isoprene nitrates, *Atmos. Chem. Phys.*, 9, 1451–1463, doi:10.5194/acp-9-1451-2009, 2009.
- Reeves, C. E., Slemr, J., Oram, D. E., Worton, D., Penkett, S. A., Stewart, D. J., Purvis, R., Watson, N., Hopkins, J., Lewism, A., Methven, J., Blake, D. R., and Atlas, E.: Alkyl nitrates in outflow from North America over the North Atlantic during Intercontinental Transport of Ozone and Precursors 2004, *J. Geophys. Res.*, 112, D10S37, doi:10.1029/2006JD007567, 2007.
- Slusher, D. L., Huey, L. G., Tanner, D. J., Flocke, F. M., and Roberts, J. M.: A thermal dissociation–chemical ionization mass spectrometry (TD-CIMS) technique for the simultaneous measurement of peroxyacyl nitrates and dinitrogen pentoxide, *J. Geophys. Res.*, 109, D19315, doi:10.1029/2004JD004670, 2004.
- Thaler, R. D., Mielke, L. H., and Osthoff, H. D.: Quantification of Nitryl Chloride at Part Per Trillion Mixing Ratios by Thermal Dissociation Cavity Ring-Down Spectroscopy, *Anal. Chem.*, 83, 2761–2766, 2011.
- Turnipseed, A. A., Huey, L. G., Nemitz, E., Stickel, R., Higgs, J., Tanner, D. J., Slusher, D. L., Sparks, J. P., Flocke, F., and Guenther, A.: Eddy covariance fluxes of peroxyacetyl nitrates (PANs) and NOy to a coniferous forest, *J. Geophys. Res.*, 111, D09304, doi:10.1029/2005JD006631, 2006.
- Wooldridge, P. J., Perring, A. E., Bertram, T. H., Flocke, F. M., Roberts, J. M., Singh, H. B., Huey, L. G., Thornton, J. A., Wolfe, G. M., Murphy, J. G., Fry, J. L., Rollins, A. W., LaFranchi, B. W., and Cohen, R. C.: Total Peroxy Nitrates (ΣPNs) in the atmosphere: the Thermal Dissociation-Laser Induced Fluorescence (TD-LIF) technique and comparisons to speciated PAN measurements, *Atmos. Meas. Tech.*, 3, 593–607, doi:10.5194/amt-3-593-2010, 2010.
- Xie, Y., Paulot, F., Carter, W. P. L., Nolte, C. G., Luecken, D. J., Hutzell, W. T., Wennberg, P. O., Cohen, R. C., and Pinder, R. W.: Understanding the impact of recent advances in isoprene photooxidation on simulations of regional air quality, *Atmos. Chem. Phys. Discuss.*, 12, 27173–27218, doi:10.5194/acpd-12-27173-2012, 2012.
- Zabel, F.: Unimolecular decomposition of peroxy nitrates, *Z. Phys. Chem.*, 188, 119–142, 1995.